Operating instructions
and instructions for commissioning

Instrument series Gamma 22



Gamma 22 B
Gamma 223 B
Gamma 2233 B

Table of contents

Page

General	3
Data storage	3
Installation notes	3
Application	3
Operating and visualization instruments	4
1. Daytime ambient temperature	4
2. Set back temperature	4
3. Selector for modes of operation	4
4. Multifunctional information - standard display	7
4.1 Information level	7
4.2 Error messages and plant diagnosis	8
5. Inquiry and programming	9
5.1 Setting of time, calendar and operating times	9
5.1.1 Setting of time and calendar.....	9
5.1.2 Setting of operating times.....	10
5.1.3 Selection of operating times Programming of operating times.....	11
5.1.4 General program structure of setting of time, calendar and operating times	12
5.1.5 Individual operating times.....	14
5.2 User level.....	17
5.3 Service level	21
5.4 Parameter summary	27
5.4.1 Parameter summary – user level	27
5.4.2 Parameter summary – service level	28
5.5 External programming via service socket	30
6. Special functions	30
7. Installation	32
7.1 Electrical installation	32
7.1.1 Electrical connection Gamma 22 B	33
7.1.2 Electrical connection Gamma 223 B	34
7.1.3 Electrical connection Gamma 2233 B	35
8. Accessories	36
9. Resistance values of the sensor elements depending on the temperature	37
10. Accessories on demand	38
11. Technical data	40

General

The control instruments of the series Gamma 22 serve as controls for heating plants with double-step burners and meet all requirements of modern heating plant controls with regard to control technique and handling.

In particular, the instruments distinguish by two essential features:

- 1 - All control functions are executed by high-efficient microprocessors. Intelligent control algorithms and practical programs, combined with the application of sophisticated technologies, guarantee an optimum energy consumption.
- 2 - Operation is analogous to the greatest possible extent. A minimum of control elements as well as a clear menu-driven programming via two keys guarantee the user an easy and comprehensive handling and avoid almost any operating errors.

The excellent symbiosis of these two features guarantees the trouble-free and customer-oriented use at an utmost comfort.

Data storage

Individually entered plant parameters and nominal values as well as current daily data remain operative even in case of a switching-off for a longer period, thanks to the integrated long-term storage and thus guarantee the safe operation of the installation for many years.

Installation notes

All electrical connections, protective- and safety measures have to be executed by a specialist under observance of the relevant standards and VDE directives as well as of the local prescriptions of the electric supply companies.

The electrical connection is to be carried out as electrical bonding according to VDE 0100.

Attention!

Before opening the patch panel the plant has to be separated from the current network.

Any plugging-in of connecting terminals under voltage can lead to the destruction of the instrument and to dangerous shocks!

Application

The operating instructions in this manual apply to three types of instruments:

– Gamma 22B

Weather dependent boiler temperature controller for double-step boilers for heating- and hot-water mode (floating operation).

– Gamma 223B

Weather dependent boiler temperature controller for double-step boilers for heating- and hot-water mode (floating operation) including a weather dependent heating circuit for a mixing valve (quasi-continuous three-point PI controller) with integrated pump logic.

– Gamma 2233B

Weather dependent boiler temperature controller for double-step boilers for heating- and hot-water mode (floating operation) including two weather dependent heating circuits for mixing valves (quasi-continuous three-point PI controller) with integrated pump logic.

Selecting the operating notes regarding the different types of instruments, the control instrument can be adapted precisely to the plant-specific conditions and the users requirements.

Important note:

The symbols  and  used in several chapters

 = Operation with room station(s)

 = Operation without room station(s)

indicate important notes which should be followed for the operation with room stations RS 10!

Operating and visualization instruments

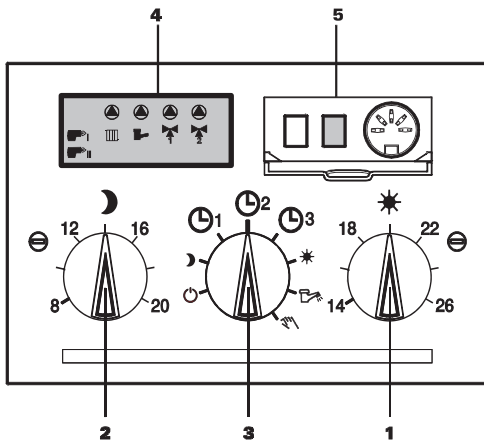

1. Daytime ambient temperature

With this knob the required daytime ambient temperature can be regulated between 14°C and 26°C. The neutral of the knob corresponds to the normal setting of 20°C.

A constant ambient temperature at any outside temperature conditions requires a correct design of the heating plant according to the heat demand analysis as well as a precise regulation of the relative heating characteristics.

The daytime ambient temperature refers equally to the direct-controlled boiler circuit as to available mixer heating circuits. Any adjustments should always be made in little steps and within a time period of 2 -3 hours in order to make sure that a steady condition has been created.

Factory preset: 20 °C (neutral)
Setting range: 14 °C ... 26 °C

2. Set back temperature

With this knob the required set back temperature during night or absence can be regulated. At a correct design of the heating plant and precisely regulated heating characteristics a uniform support operation results at any occurring outside temperature conditions.

The set back temperature refers equally to the direct-controlled boiler circuit and available mixer heating circuits. Even in this case any adjustments should be made step by step and after sufficient time periods in order to guarantee the keeping-up of the support temperatures.

Factory preset: 14 °C (neutral)
Setting range: 8 °C ... 20 °C

Note: The regulations for daytime- and set back temperature are valid only for **weather dependent** heating circuits within on control unit Gamma 2233B.

R In case a heating circuits is operated with a room station, the instrument receives the values of nominal daytime- and set back temperature exclusively from the room station.

3. Selector for modes of operation

With an 8-step selector switch different practical heating- and hot-water programs can be selected individually according to current requirements.

☰ - Standby mode

With this knob position, the switching-off of all control functions with permanent frost monitoring is achieved. All heating circuit pumps are disconnected, possibly existing mixers are closed.

At outside temperatures below frost-protection limit, the heating circuits are controlled according to the preset minimum temperature. Pump and mixer remain in operation.

At this mode, the hot-water mode is principally locked, however, protected against frost. If the tank temperature should drop below 5 °C, the tank temperature is increased automatically to 8 °C.

R At the operation **without** room station(s), the heating circuits are **controlled** beyond the minimum delimitation according to a minimum ambient temperature of +10 °C with relatively reduced heating characteristics.

R At the operation **with** room station(s), the heating circuits are **regulated** considering the minimum temperature delimitation, minimum ambient temperature and monitoring of the current ambient temperature.

These measures guarantee the extensive protection of the building at low outside temperatures by avoiding ventilation and air condensation.

Application:

Switching-off of the instrument at complete protection of the building.

☛ - Permanent set back mode

With this knob position, a continuously reduced mode of all heating circuits is obtained according to the preset ambient temperature, considering the preset minimum temperatures. Hot water is prepared according to the operating-time programming at the automatic program ☛ - 2 (hot-water circuit) and preset nominal hot-water value.

Application:

Permanent set back mode during transitional period or winter time in case of longer absence (winter holidays).

Automatic programs (☛ -1, ☛ -2, ☛ -3)

At the automatic mode, three operating-time programs with different seizure characteristics are available. During commissioning, these are called according to the selector switch position ☛ - 1, ☛ - 2 or ☛ - 3 as standard programs defined by the manufacturer and cannot be lost and, if necessary, can be overwritten by individual operating times after corresponding treatment at the operating time level (see setting of operating times).

At all three automatic programs, for every circuit, two heating cycles for each weekday with one switching-on and switching-off time each are provided. In case of standard programs, depending on the selected program, these are seized by the manufacturer with one or two heating cycles according to the following operating-times tables.

☛ - 1 – Automatic program 1

This mode should be selected if during daytime an additional reduction of the heating circuits shall take place.

Heating circuit	Day	Heating on from to	Instrument
Boiler circuit	Mon – Fri	5.00 - 8.00	22B
	Sat, Sun	16.00 - 22.00 7.00 - 23.00	223B 2233B
Hot-water circuit	Mon – Fri	4.30 - 8.00	22B
	Sat, Sun	15.30 - 22.00 6.30 - 23.00	223B 2233B
Mixer heating circuit 1	Mon – Fri	5.00 - 8.00	22B
	Sat, Sun	16.00 - 22.00 7.00 - 23.00	223B 2233B
Mixer heating circuit 2	Mon – Fri	5.00 - 8.00	22B
	Sat, Sun	16.00 - 22.00 7.00 - 23.00	223B 2233B

☛ - 2 – Automatic mode 2

This mode should be selected if during daytime a uniform continuous heating is required for all week days.

Heating circuit	Day	Heating on from to	Instrument
Boiler heating circuit	Mon - Sun	5.00 - 22.00	22B 223B 2233B
Hot-water Circuit	Mon - Sun	4.30 - 22.00	22B 223B 2233B
Mixer heating circuit 1	Mon - Sun	5.00 - 22.00	22B 223B 2233B
Mixer heating circuit 2	Mon -Su	5.00 - 22.00	22B 223B 2233B

☛ - 3 – Automatic mode 3

This mode is designed especially for heating plants with combined radiator and underfloor systems. Due to the sluggishness of underfloor systems, a premature heating and temperature reduction with regard to the boiler heating circuit takes place.

Heating circuit	Day	Heating on from to	Instrument
Boiler circuit	Mon – Fri	5.00 - 22.00	22B
	Sat, Sun	7.00 - 23.00	223B 2233B
Hot-water circuit	Mon – Fri	4.30 - 22.00	22B
	Sat, Sun	6.30 - 23.00	223B 2233B
Mixer heating circuit 1	Mon – Fri	4.00 - 20.30	22B
	Sat, Sun	6.00 - 22.00	223B 2233B
Mixer heating circuit 2	Mon – Fri	4.00 - 20.30	22B
	Sat, Sun	6.00 - 22.00	223B 2233B

For all three automatic programs, the control of the hot-water temperature is effected according to the manufacturer's regulation of 50 °C or according to an individually entered nominal hot-water value.

Attention: Each heating circuit controlled by a room station separates itself automatically from the preset operating-times program of the central unit and regulates according to the preset operating-times program of the appertaining room station RS 10.

R



At the operation **without** room station(s), the heating circuits during resp. between the heating cycles are controlled according to the allowance of the preset daytime ambient resp. reduction temperature.



At the operation **with** room station(s), for each weekday **all three heating cycles** can in addition be admitted with differently adjustable ambient and hot-water temperature allowances.

Application:

Emission measurement
Malfunction of the controller
Disturbances

*** - Permanent daytime mode**

This knob position allows a continuous heating according to the specified daytime ambient temperature under consideration of the preset minimum delimitation values.

Hot-water preparation is achieved according to the operating-times programming at the automatic program ☉ – 2 (hot-water circuit) and preset nominal hot-water value.

Application:

Permanent heating operation around the clock.



- Exclusive hot-water mode

With this knob position only the hot-water mode remains in operation and controls the hot-water temperature according to the factory preset of 50 °C or according to the individually preset nominal value. Hot-water preparation is achieved at the operating times determined at the automatic programs.

The heating mode of all existing heating circuits is interrupted, however, remains protected against frost.

Application:

Manual summer operation, switching-off of the heating mode in case of multiple dwellings at the end of the heating period with unlimited hot-water mode.



- Manual mode

At this mode, all control functions are deactivated. Boiler temperature is regulated according to the regulation of the boiler temperature controller (boiler thermostat). The circulation pumps of all connected heating circuits remain absolutely in operation. Possibly connected mixers are free of voltage and can be actuated manually according to the current heating requirements. For this purpose, the indications of the manufacturer and the installation specialists have to be followed.

4. Multifunctional information - standard display

At commissioning of the instrument, at first all available segments appear on the display.

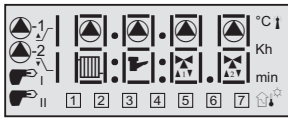

Segment test

Then the indication changes to the standard display (functional indication).



Standard display operability indication

Operability indication

The symbols appearing on the standard display have the following informational character:

Burner status:



burner request burner step 1



burner request burner step 2

Heating circuits:

Log-in and log-out of the circuits is done via the set function (see page 30).



boiler heating circuit is logged-in



hot-water circuit is logged-in



mixer heating circuit 1 is logged-in



mixer heating circuit 2 is logged-in

Note: Heating circuits which, depending on the execution of the plant, are not available or logged-out do not appear on the display.

Mixer control commands:



mixer (1 resp. 2) opens



mixer (1 resp. 2) closes

Operability indication (heating circuits)

If the pump symbol  appears **above** the appertaining heating circuit, this circuit is ready for operation.



boiler heating circuit pump in function
(heating request boiler heating circuit)

hot-water loading pump in function
(hot-water request)

mixer heating circuit pump 1 in function
(heating request mixer heating circuit 1)

mixer heating circuit pump 2 in function
(heating request mixer heating circuit 2)

4.1 Information level

On this level, the following temperatures can be inquired in succession via the blue key.

Outside-temperature inquiry





Operability indication

Symbol appears only at activated summer switching-off

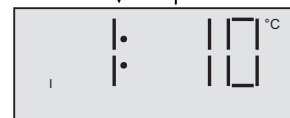
blue key   yellow key



outside temperature 1

blue key   yellow key

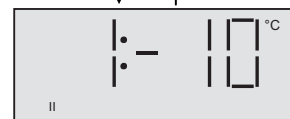

outside temperature 2

(only with connected and registered outside sensor AF 2)

Time- / weekday inquiry

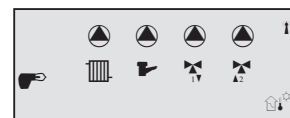

Operability indication

yellow key   blue key

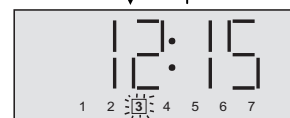

Time weekday (in frames)

4.2 Error messages and plant diagnosis

All control instruments are equipped with an extensive error indicating logic which, depending on the execution of the instrument, indicates the kind of the error.

Note: Error messages have priority over all other indications and remain active until the elimination of the disturbance.

A – Sensor error messages

Sensor	Kind of error	Display	Error diagnosis
Boiler sensor (total flow sensor)	Interruption		Flashing symbol around the boiler heating circuit .
	Short circuit		Flashing symbol over the boiler heating circuit .
Hot-water sensor	Interruption		Flashing symbol around the hot-water circuit .
	Short circuit		Flashing symbol over the hot-water circuit .
Flow sensor Mixer heating circuit 1	Interruption		Flashing symbol around mixer heating circuit 1 .
	Short circuit		Flashing symbol over mixer heating circuit 1 .
Flow sensor Mixer heating circuit 2 (return flow sensor)	Interruption		Flashing symbol around mixer heating circuit 2 .
	Short circuit		Flashing symbol over mixer heating circuit 2 .
Outside sensor 1(2)	Interruption (Example: outside sensor 2)		Flashing triple symbol with sensor indication I resp. II for the operation with two outside sensors
	Short circuit (Example: outside sensor 1)		Flashing triple symbol with sensor indication I resp. II for the operation with two outside sensors

B – Systematic error messages

Heating circuit	Kind of error	Display	Error diagnosis
Boiler heating circuit	No increase of the boiler temperature below 30 °C in spite of burner request		Flashing burner symbol Check burner, if necessary inform heating plant specialist.

C – Data bus error messages (only in case of several control units for extension of heating circuits)

Central unit	Kind of error	Display	Error diagnosis
1...5	No data exchange between the extended control units. Control functions completely or partially disturbed		Flashing address error message (multiple seizure of the same bus address) Check bus address at the professional level of the individual instruments and, if necessary, new allocation.

5. Inquiry and programming

After opening the hinged cover at the right side of the visualization panel, the yellow and blue programming keys next to the service socket become accessible. With these keys the following inquiries and programming procedures can be carried out:

- Information level (time – outside temperature)
- Setting of time, calendar and operating times
- User level
(programming by the user of the plant)
- Service level
(programming by the heating plant specialist)
- Programming via service socket
- Configuration of the plant
(special functions)

5.1 Setting of time, calendar and operating times

5.1.1 Setting of time and calendar

All daily values such as time, calendar day, month and year are updated by the manufacturer and principally do not require any correction.

Automatic summer-/wintertime reset

A calendar programmed until the year 2094 considers the yearly repeating reset dates (each time on the last Sunday in October and March). A time correction is not necessary.

If in exceptional cases a correction of the current daily values should be necessary, these values can be called and corrected in the order as described below in the time- and calendar setting mode.

Entry into the setting of time, calendar and operating times

For the entry into the setting mode, the yellow key has to be actuated for approx. 5 seconds until the first day value (time – **minutes**) appears on the indication.

All further values are called by a short actuation of the yellow key.

At setting mode, values which can be modified are indicated flashing and can be corrected via the blue key.

keep the yellow key pushed for approx. 5 sec.

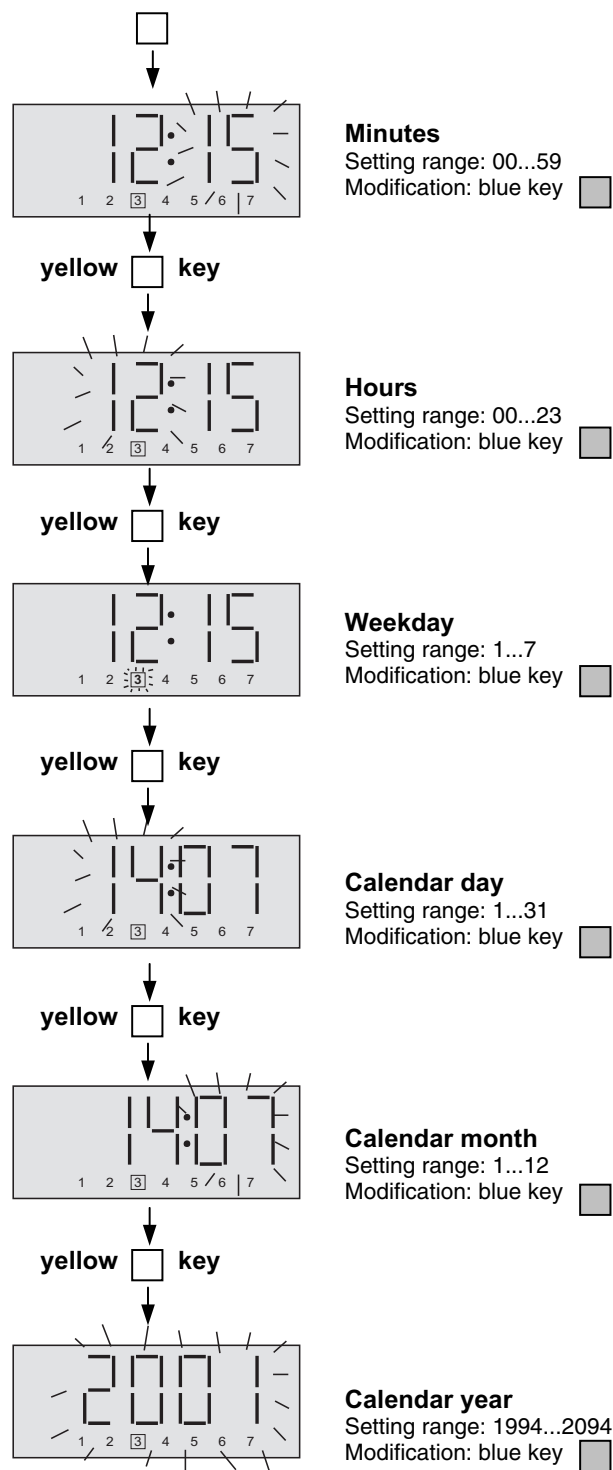

A further actuation of the **yellow** key leads to the setting of operating times (selection of the heating circuit).

5.1.2 Setting of operating times

The standard operating times (standard programs) preset by the manufacturer in the three automatic programs ☉ -1, ☉ -2 and ☉ -3 can be modified for each heating circuit according to the execution of the instrument.

In this way, tailor-made heating programs with different switching-on and switching-off times for each weekday can be obtained

Selection of heating circuit

The setting mode for the operating times is called after the calendar- /time setting. After the last setting value (calendar year) has shown, by repeated actuation of the yellow key the heating circuit can be selected in the order

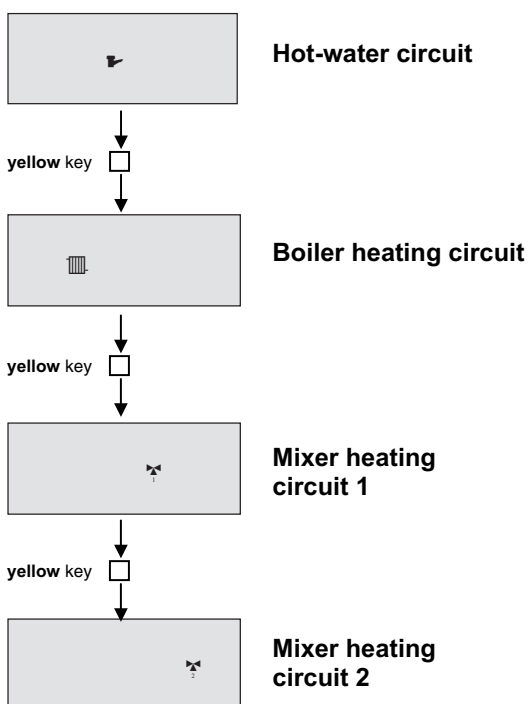

each selected circuit can then be modified individually with regard to its switching-on and switching-off times.

For this purpose, the setting of operating times is entered **for the first time via the blue key** (see selection of operating times).

If, after selection of the **last heating circuit** the **yellow key** is actuated, reentry from the operating times level to the standard display is done.

Without any actuation of the keys, after approx. 60 seconds the standard display appears again (automatic reentry).

The level structures shown on the following pages gives a complete survey on the time-/calendar and operating times level.

Important notes for the operating times programming

Operating times reset (clear)

After calling the last switching-off time on the last weekday (Sunday), with a further actuation of the yellow key, the reset function for operating times (readiness for reset) appears.

With this function, all individually programmed switching-on and switching-off times of the last selected circuit can be replaced by the appertaining standard operating times of the corresponding program ☉ -1, ☉ -2 or ☉ -3.

At readiness for reset (indication =: CL) the operating times are cleared by actuating the **blue key for approx. 5 seconds**. The feedback **SEt** appears as confirmation.

Attention:  **Individually entered operating time programs are lost at clearing and must be entered again.**

Operating times control

For each circuit maximum two heating cycles per day can be entered which, after completion of the programming and new call are indicated at the entered order.

Day-overlapping heating cycles

If a heating cycle to be programmed covers two days (i.e. switching-off time on the following day), the corresponding time periods for both days have to be entered. The cycle has to be split into two partial cycles:

- 1- Start of cycle (switching-on time) up to 23.30 h (switching-off time)
- 2- Continuation of cycle (switching-on time) from 00.00 h of the following day until end of cycle.

Clearing of cycles

For clearing a cycle, the relative switching-on **and** switching-off times have to be set at **00.00**.

Thus the cycle is defined as idle cycle (no operating times).

Exception: 00.00 is allowed as switching-on time, 00.00 as switching-off time, however, clears the complete cycle!

5.1.3 Selection of operating times Programming of operating times

At the programming of operating times, for each automatic program ① 1, ② 2 or ③ 3 the heating circuits as well as the hot-water circuit can be programmed each with two **different** heating cycles for each weekday.

Entry into the operating times programming

After selecting the heating-/ resp. hot-water circuit to be programmed, entry into the operating times programming is achieved for the first time via the **blue** key.

Simultaneously, the first switching-on time on the first weekday (Monday) is indicated

The following operating times are called alternating from switching-on to switching-off times via the **yellow** key and can then be modified via the **blue** key in increasing steps of 30 minutes.

Commutation to the next weekday is done automatically by calling a first switching-on time.

Before the corresponding operating time appears, the appertaining status

\overline{ON} = switching-on time (heating start)
resp.
 \overline{OFF} = switching-off time (heating end)

shows for a short time (approx. 2 sec.) to mark a switching-on or switching-off time.

Additionally, the corresponding cycle number

- 1 for the first heating cycle
- 2 for the second heating cycle

appears at the upper left part of the indication which, depending on the selected automatic program marks the first or second switching-on resp. switching-off time.

After calling the last switching-off time on the last weekday, the just programmed heating circuit is called again via the **yellow key** so that the entered operating times can be checked (see **Entry into the single-day programming**).

At a further actuation of the yellow key the subsequent heating circuits or (after selecting the last circuit) the standard display appears.

The below scheme shows the single-day programming in all individual steps.

Attention: In case only one cycle is required for each weekday, the second switching-on time as well as the second switching-off time has to be set at 00.00. Thus the second cycle is cleared.

5.1.4 General program structure of setting of time, calendar and operating times

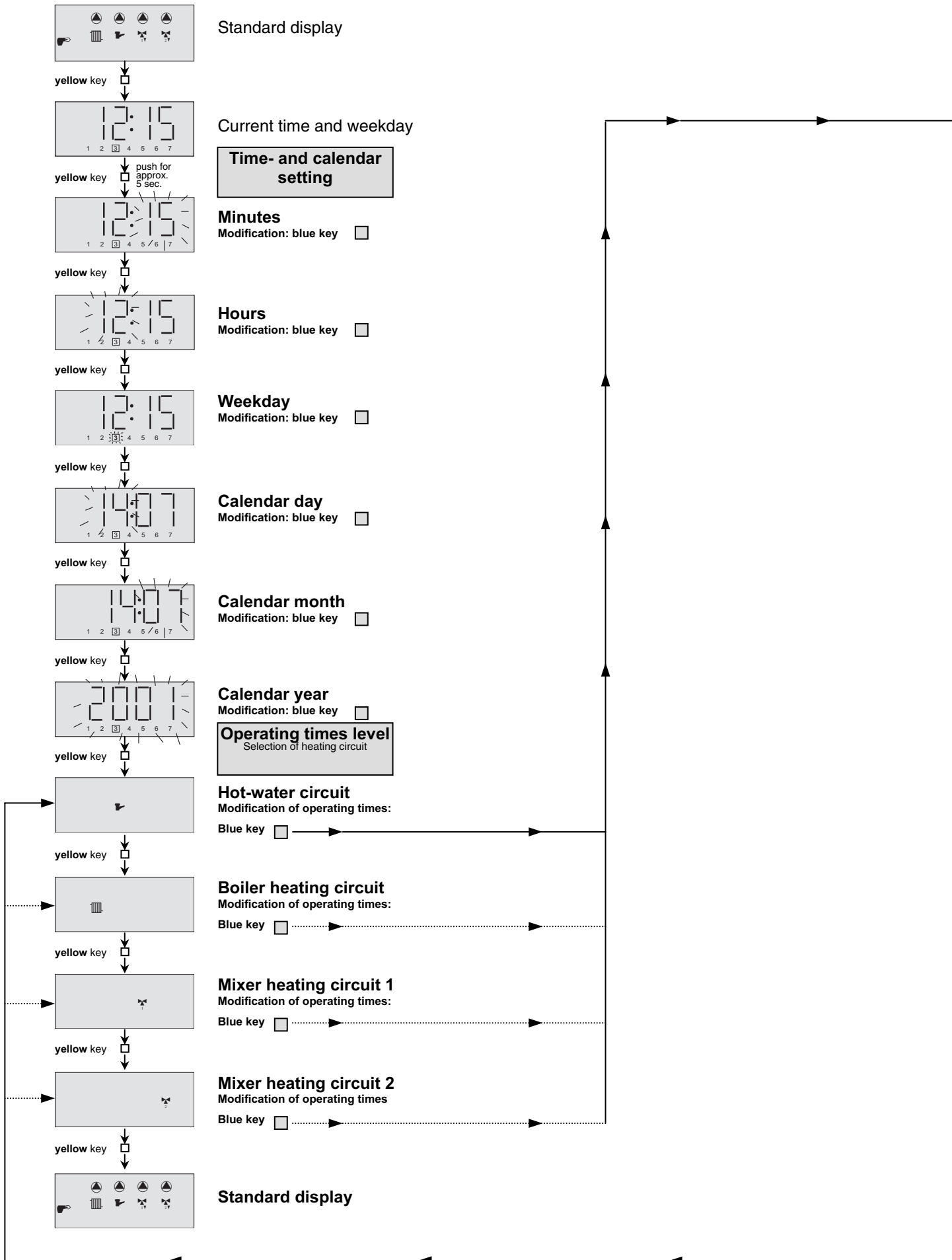

Attention: Prior to programming the desired operating times program ☉ - 1, ☉ - 2 or ☉ - 3 has to be selected on the central unit.

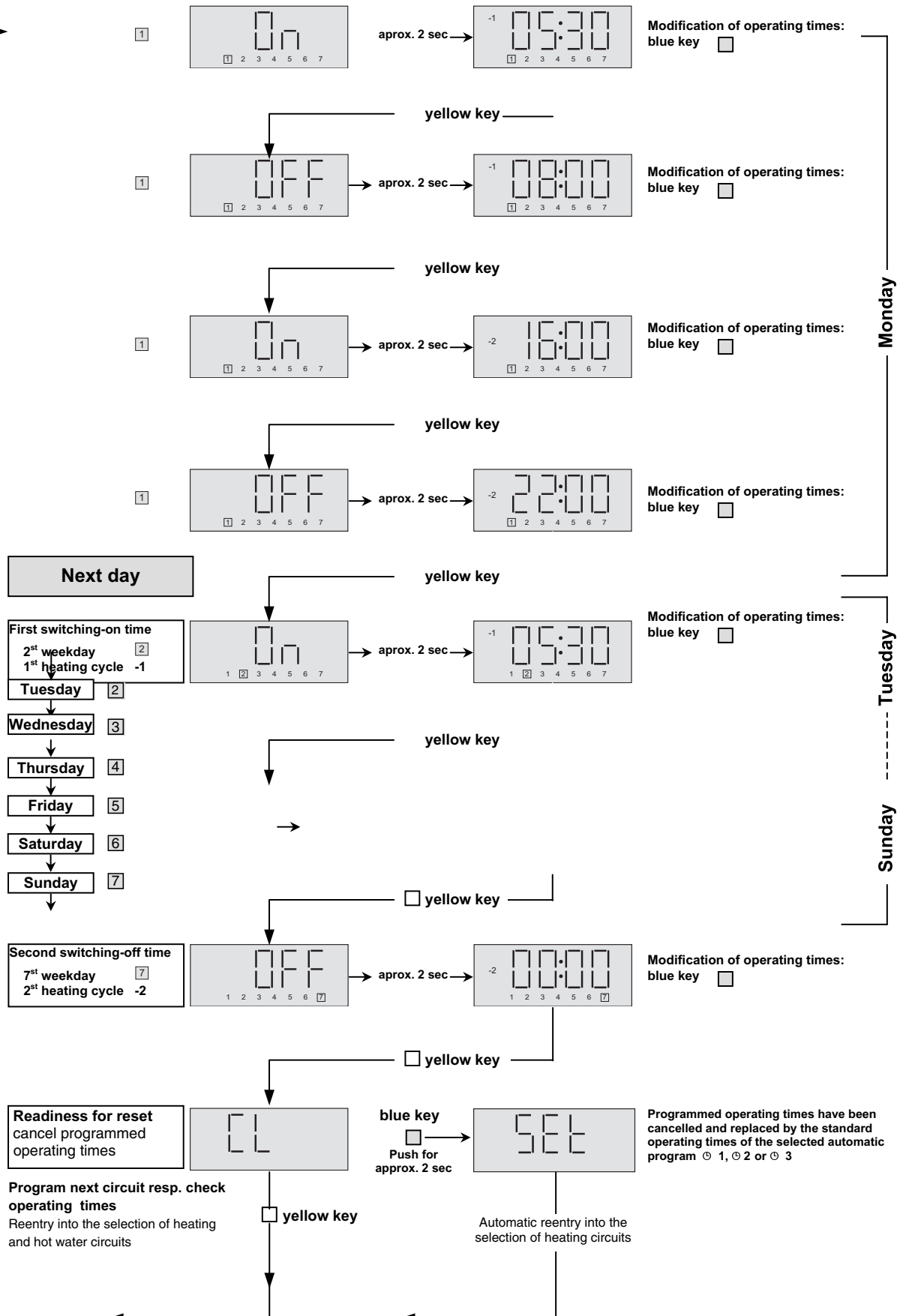

5.1.5 Individual operating times

⊕ 1 – Automatic program 1

Heating circuit		Heating cycle I		Heating cycle II	
		1 st switching-on time	1 st switching-off time	2 nd switching-on time	2 nd switching-off time
Mon 1	Boiler heating circuit				
	Hot-water circuit				
	Mixer heating circuit 1				
	Mixer heating circuit 2				
Tue 2	Boiler heating circuit				
	Hot-water circuit				
	Mixer heating circuit 1				
	Mixer heating circuit 2				
Wen 3	Boiler heating circuit				
	Hot-water circuit				
	Mixer heating circuit 1				
	Mixer heating circuit 2				
Thi 4	Boiler heating circuit				
	Hot-water circuit				
	Mixer heating circuit 1				
	Mixer heating circuit 2				
Fri 5	Boiler heating circuit				
	Hot-water circuit				
	Mixer heating circuit 1				
	Mixer heating circuit 2				
Sat 6	Boiler heating circuit				
	Hot-water circuit				
	Mixer heating circuit 1				
	Mixer heating circuit 2				
Sun 7	Boiler heating circuit				
	Hot-water circuit				
	Mixer heating circuit 1				
	Mixer heating circuit 2				

Individual operating times

⊕ 2 – Automatic program 2

Heating circuit		Heating cycle I		Heating cycle II	
		1 st switching-on time	1 st switching-off time	2 nd switching-on time	2 nd switching-off time
Mon 1	Boiler heating circuit				
	Hot-water circuit				
	Mixer heating circuit 1				
	Mixer heating circuit 2				
Tue 2	Boiler heating circuit				
	Hot-water circuit				
	Mixer heating circuit 1				
	Mixer heating circuit 2				
Wen 3	Boiler heating circuit				
	Hot-water circuit				
	Mixer heating circuit 1				
	Mixer heating circuit 2				
Thi 4	Boiler heating circuit				
	Hot-water circuit				
	Mixer heating circuit 1				
	Mixer heating circuit 2				
Fri 5	Boiler heating circuit				
	Hot-water circuit				
	Mixer heating circuit 1				
	Mixer heating circuit 2				
Sat 6	Boiler heating circuit				
	Hot-water circuit				
	Mixer heating circuit 1				
	Mixer heating circuit 2				
Sun 7	Boiler heating circuit				
	Hot-water circuit				
	Mixer heating circuit 1				
	Mixer heating circuit 2				

Individual operating times

⊕ 3 – Automatic program 3

Heating circuit		Heating cycle I		Heating cycle II	
		1 st switching-on time	1 st switching-off time	2 nd switching-on time	2 nd switching-off time
Mon 1	Boiler heating circuit				
	Hot-water circuit				
	Mixer heating circuit 1				
	Mixer heating circuit 2				
Tue 2	Boiler heating circuit				
	Hot-water circuit				
	Mixer heating circuit 1				
	Mixer heating circuit 2				
Wen 3	Boiler heating circuit				
	Hot-water circuit				
	Mixer heating circuit 1				
	Mixer heating circuit 2				
Thi 4	Boiler heating circuit				
	Hot-water circuit				
	Mixer heating circuit 1				
	Mixer heating circuit 2				
Fri 5	Boiler heating circuit				
	Hot-water circuit				
	Mixer heating circuit 1				
	Mixer heating circuit 2				
Sat 6	Boiler heating circuit				
	Hot-water circuit				
	Mixer heating circuit 1				
	Mixer heating circuit 2				
Sun 7	Boiler heating circuit				
	Hot-water circuit				
	Mixer heating circuit 1				
	Mixer heating circuit 2				

5.2 User level

Programming by the user of the plant

This program level is mainly reserved for the user of the plant and serves for indication or correction of plant-specific setting values which refer to individual heat requirements and consumption-typical information.

These programming steps include

- settings of heating characteristics of the heating circuits
- reduced mode
- nominal hot-water temperature
- legionella protection
- parameter reset
- indication of operating hours of burner
- indication of burner starts

which are called subsequently in the above order.

Entry into the user level

The user level is entered by actuating the blue key for approx. **5 seconds** at the standard display mode. After the level indication has shown, the first parameter of the user level appears.

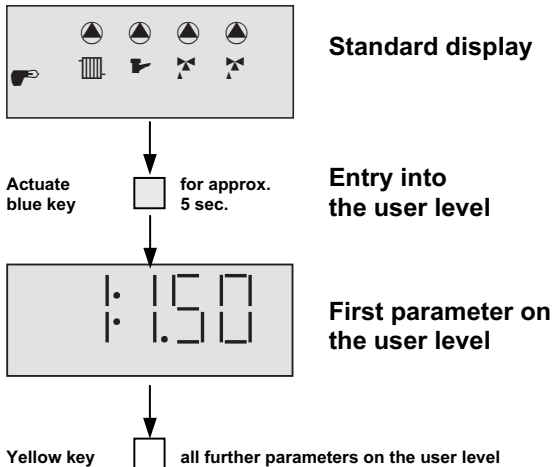

Selection and modification of parameters

All other parameters are called with the yellow key and, if necessary, can be modified with the blue key.

Note: **Parameters** are called unidirectional (increasing parameter numbers) by repeated actuation of the yellow key. After calling the last parameter re-entry into the standard display is done by actuating the key again.

Modifications can be executed only unidirectional (increasing values). After the final value has been reached, the indication returns to the initial value by actuating the blue key.

Individual setting values should be noted in the parameter summary **User level** (see page 37).

Slopes of heating characteristics

Boiler heating circuit

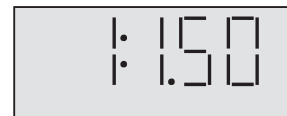

Parameter 1:
All instruments

Factory preset: 1.50

Setting range: 0.20...3.50

Modification: blue key

Next parameter: yellow key

5.2.1.1.1 Slope of heating characteristics

Mixer heating circuit 1

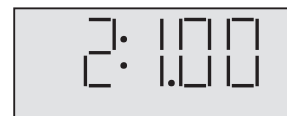

22 B : not available
223B : **Parameter 2**
2233 B : **Parameter 2**

Factory preset: 1.00

Setting range: 0.20...3.50

Modification: blue key

Next parameter: yellow key

Slope of heating characteristics

Mixer heating circuit 2

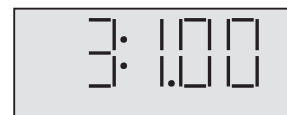

22 B : not available
223B : not available
2233 B : **Parameter 3**

Factory preset: 1.00

Setting range: 0.20...3.50

Modification: blue key

Next parameter: yellow key

The slope of the heating characteristic describes the relation of boiler (resp. flow-pipe) temperature modification to outside temperature modification.

The slope value refer to a design outside temperature of -12°C taken as basis of the heat requirement calculation.

Other design values can be set by the heating plant specialist depending on the corresponding climatic zones.

The heating characteristics should be modified only in small steps and after sufficient long time periods so that, with the normally rather sluggish heating systems, a steady condition can be obtained.

Corrections are recommended in steps from 0.1 after 1 – 2 days.

Heating characteristics diagram (Valid for all heating circuits)

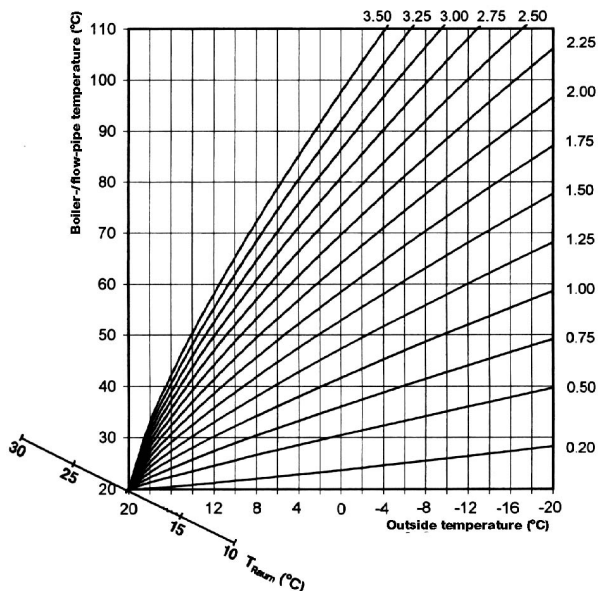

For the operation without room station, for a precise reset of the heating characteristics, the selector switch should be positioned temporarily at continuous day mode (*) in order to not disturb the stabilizing process by temperature decreasing periods.

Furthermore, the most frequented room should be considered to observe the ambient temperature.

If the heating surfaces are correctly dimensioned, thermostat valves only serve to regulate external heat and should nearly be opened completely. During setting period, additional heat sources such as open fireplaces, tiled- and other stoves, etc.) should not be operated. Furthermore, one should not let in too much air during this period.



For the operation with room stations an automatic adaption (= regulating) of the heating characteristics takes place if the corresponding parameter has been activated. During adaption period, the indicated slopes value appears flashing on the room station RS 10.

At correctly regulated heating characteristics the room temperature remains constant according to the set daytime ambient temperature **independent** from modifications of the outside temperature.

Recommended setting values

Underfloor heating systems: 0.30...1.00

Radiator heating systems: 1.25...2.20

Convactor heating systems: 1.50...2.20

Next parameter: yellow key

Reduced mode



22 B : **Parameter 2**
223B : **Parameter 3**
2233 B : **Parameter 4**

Factory preset: ECO

Setting range: ECO – Abs

Modification: blue key

During the reduced mode two operational modes can be selected.

1 – Temperature-decreasing mode (Abs)

During the reduced mode (see operating-times program), the heating circuit pump of the decreased heating circuit remains in operation. The boiler- resp. flow-pipe temperatures are specified by reduced heating characteristics according to the decreased ambient temperature. Temperature will not drop below the preset minimum temperature of the decreased heating circuit.

Application: Buildings with low insulation values and high cooling losses.

2 – Eco mode (ECO)

During reduced mode the corresponding heating circuit is totally switched off if the outside temperature is above the preset frost- protection limit.

For mixer heating circuits

- the heating circuit pumps are switched off
- the mixers are closed
- the minimum temperature delimitation is out of function.

For the boiler heating circuit

- the heating circuit pump is switched off decelerated (pump lag to avoid a safety switching-off at a re-heating of the boiler)
-
- the minimum temperature delimitation is out of function.

In case the outside temperature should be or drop below the preset frost-protection limit, the controller changes from the switched-off mode to the **reduced mode** and controls the heating circuit temperature according to the preset temperature reduction characteristics under consideration of the preset minimum temperature allowances.

Application: Buildings with high insulation values (complete heat protection).

Attention: At activated ECO mode all **temperature reduction functions** are changed into **switching-off functions**. The position of the selector switch  – (constant temperature reduction mode) causes a frost-safe **switching-off mode**.

Next parameter: yellow key

Nominal hot-water value

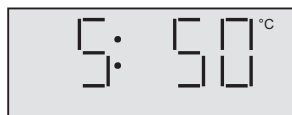

22 B : **Parameter 3**
 223B : **Parameter 4**
 2233 B : **Parameter 5**

Factory preset: 50 °C
 Setting range: 20...80 °C

Modification: blue key

This parameter specifies the desired hot-water temperature.

If the current temperature drops below the set value, the tank is reloaded up to the set nominal value plus the preset hot-water switching difference. The tank loading pump is switched off decelerated in order to avoid a safety switching-off due to re-heating of the boiler.

Next parameter: yellow key

Legionella protection (day)



22 B : **Parameter 4**
 223B : **Parameter 5**
 2233 B : **Parameter 6**

Factory preset: OFF
 Setting range: OFF, 1...7 (weekday)

Modification: blue key

Legionella protection is activated at the programmed weekday (1...7) between 21:00 – 22:00 o'clock.

If, at that time, the hot-water temperature should be below 65 °C, an intermediate re-loading of the hot-water boiler up to 70 °C takes place in order to avoid a infestation with legionella.

At set value **OFF** legionella protection is not activated.

Next parameter: yellow key

Parameter reset

(User level)

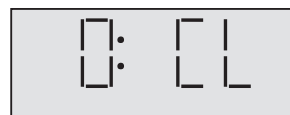

All instruments

push blue key for approx. 5 sec.

At reset the previous parameters 1 – 5 are reset to the factory preset values.

Attention: Reset must be carried out only if all individually entered values shall be replaced by the factory preset values!



In case of reset the indication



Reset completed

appears on the display as confirmation.

With a further activation of the yellow key, the data relating to the burner (operating hours, burner starts) of both burner steps are called.

Next parameter: yellow key

Burner runtime – burner step 1



Operating hours
(total h total burner step 1)

Factory preset: 0000 h
Indicating range: 0000...19999 h

Reset: actuate blue key **for approx. 5 sec.**

Next parameter: yellow key

Acquisition of burner starts – burner step 1



Burner starts
(total n total burner step 1)

Factory preset: 0000
Indicating range: 0000...19999 (starts)

Reset: actuate blue key **for approx. 5 sec.**

Next parameter: yellow key

Burner runtime – burner step 2



Operating hours
(total h total burner step 2)

Factory preset: 0000 h
Indicating range: 0000...19999 h

Reset: actuate blue key **for approx. 5 sec.**

Next parameter: yellow key

Determination of burner starts – burner step 2



Burner starts
(total n total burner step 2)

Factory preset: 0000
Indicating range: 0000...19999 (starts)

Reset: actuate blue key **for approx. 5 sec.**

Acquisition of the operating hours of the burner serves at one hand as supporting information for the statement of heating costs and, on the other hand, as a delimitation value for necessary maintenance works.

The number of running hours of the burner refers to the actual runtimes of the burner if a feedback is given by the burner.

The indication of the burner starts can give information on the economic use of a heating plant, since the amount of standstill losses is reduced by longer runtimes of the burner and a smaller number of the burner starts. A measure for this is the medium burner runtime (i.e. switching-on time of the burner per burner start) which results out of the quotient of total runtime and total burner starts.

$$t_{\text{Burner average}} = \frac{h_{\text{total burner}}}{n_{\text{total burner}}} \text{ min/start}$$

Attention: The running hours and burner starts are counted only at connected feedback line!

In case of burners without feedback (atmospheric gas burners, etc.) the feedback entry BZ (terminal X2-20) can be shunted with the burner output (terminal X3-1). In this case, all burner-specific delay times are counted. If these are known, (multiplied with the number of burner starts) they can be subtracted.

Note: At the end of the heating period, burner operating hours as well as burner starts can be remarked into the parameters summary **User level** (page XX) and be reset to zero.

Exit from the user level

Exit from the user level is achieved by a further actuation of the yellow key or automatically **without** any further actuation after approx. 60 seconds with change-over to the standard display.

5.3 Service level

Programming by the heating plant specialist only

The service level requires a comprehensive knowledge of control-technical processes and system hydraulic and is exclusively reserved for the heating plant specialist. This level contains control-technical parameters which require a precise adaptation to the different types of plant in order to guarantee a trouble-free and most economic possible operation of the heating plant.

Parameters of the service level

The service level contains the following parameters:

- frost-protection limit
- summer switching-off
- boiler start protection
- minimum boiler temperature delimitation
- maximum boiler temperature delimitation
- burner differential 1
- burner differential 2
- switching-on deceleration burner step II
- excessive boiler temperature
- minimum burner runtime
- minimum temperature delimitation of mixer heating circuit 1
- maximum temperature delimitation of mixer heating circuit 1
- minimum temperature delimitation of mixer heating circuit
- maximum temperature delimitation of mixer heating circuit 2
- hot water priority/parallel mode
- hot water tank discharge protection
- hot water loading pump lag
- bus address
- summer-/winter reset
- step mode
- parameter reset

Entry into the service level

At called standard display entry is achieved by simultaneous actuation of the **yellow and blue key** (push for approx. 5 sec.) and is confirmed with the indication »HF« (Heizungsfachmann = heating specialist).

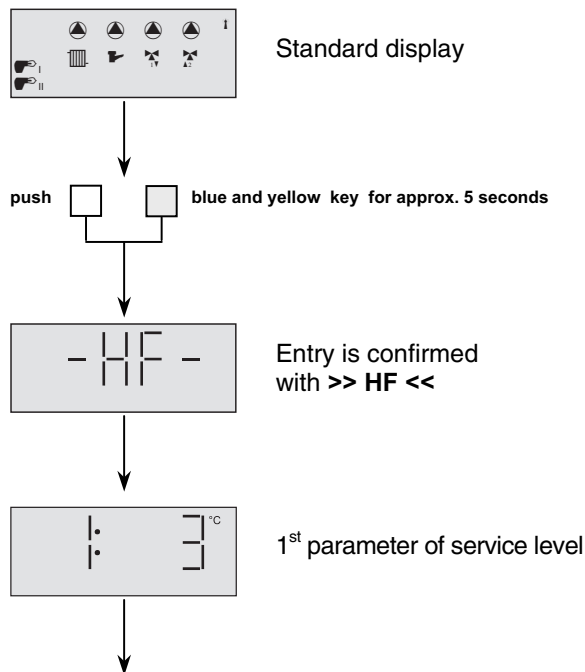

After this level indication the first parameter appears automatically and can be modified with the **blue** key.

All further parameters are selected in succession with the **yellow** key and, if necessary, can be modified with the **blue** key.

Note: **Parameters** are called uni-directionally (increasing parameter numbers). After calling the last parameter, re-entry into the standard display is done by actuating the **yellow** key again.

Modifications can be executed only uni-directionally (increasing values). After the final value has been reached, the indication returns to the initial value by actuating the **blue** key.

Frost protection limit



Parameter 1:
All types of instrument

Factory preset: 3 °C
Setting range: -10...+10 °C

Modification: blue key

The control instrument is equipped with an electronic frost protection in order to avoid a freezing up of the heating plant at switching-off mode.

If the current outside temperature is below the set delimitation value, heating operation is released according to the requirements.

The heating circuit pumps are put into operation, mixers (if available) open, the minimum boiler temperature does not fall below the limit.

Attention: Setting values minor than the factory preset (+3 °C) may be selected only if the frost protection of the plant is guaranteed by corresponding constructional measures.

Next parameter: yellow key

Summer switching off

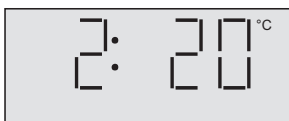

Parameter 2:
All types of instrument

Factory preset: 20 °C
Setting range: 10...30 °C

Modification: blue key

Summer switching-off works according to two different criteria:

1 – Rapid switching-off

(rapid outside temperature increase)

Heating is interrupted if the current (real) outside temperature exceeds the set value by 2K.

2 – Switching-off according to mean temperatures

(slow temperature increase)

Heating is interrupted if current and mean outside temperature reach the set value.

In both cases, heating is activated again if **current and mean outside temperature** together are below the set value by at least 1 K

At activated summer switching-off, boilers and heating circuit pumps are put out of operation. Mixers (if available) are closed. Hot-water preparation remains in function according to the preset heating program.

Next parameter: yellow key

Boiler start protection



Parameter 3:
All types of instrument

Factory preset: 1
Setting range: ON, OFF

Modification: blue key

The boiler start protection serves as protection of the boiler against corrosion caused at heating at cold condition (condensation at the dew point range). Should the boiler temperature drop below the minimum delimitation value by 2 K, all heating circuits are separated from the boiler at the water side (pumps OFF, mixers closed) in order to pass the dew point as fast as possible.

The heating circuits are released as soon as the boiler temperature has exceeded the minimum delimitation value plus half the burner differential.

OFF = boiler start protection is switched off

Minimum boiler temperature delimitation

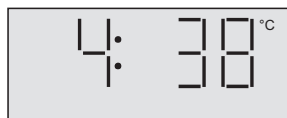

Parameter 4:
All types of instrument

Factory preset: 38 °C
Setting range: 10...95 °C

Modification: by authorized specialists only, after consultation of the boiler manufacturer.

Depending on the type of the heating boiler, the control instrument possesses a minimum delimitation regulation preset by the manufacturer.

The boiler is switched on if the set value is not reached and switched off if set value and preset burner differential have been exceeded.

During heating mode temperature will not drop below the set delimitation value.

Exceptions: Switching-off at standby mode above frost-protection limit

Switching-off at reduced automatic mode with activated ECO function

Switching-off at permanent reduced mode with activated ECO function

Automatic summer switching-off

Next parameter: yellow key

Maximum boiler temperature delimitation

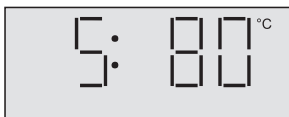

Parameter 5:
All types of instrument

Factory preset: 80 °C
Setting range: 10...95 °C

Modification: blue key

The control instrument possesses an electronic maximum boiler temperature delimitation. If the temperature increases up to 2 K below the set delimitation value, the following step is switched off. At a further increase of the boiler temperature over the set value, the leading step is put out of operation. The leading step is switched on again at 2 K, resp. at 4 K for the following step below the set value of the maximum boiler temperature delimitation.

Next parameter: yellow key

Burner differential 1

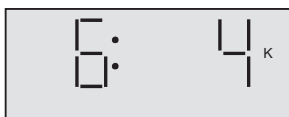

Parameter 6:
All types of instrument

Factory preset: 4 K
Setting range: 2...30 K

Modification: blue key

Next parameter: yellow key

Burner differential 2



Parameter 7:
All types of instrument

Factory preset: 8 K
Setting range: 2...30 K

Modification: blue key

The control instrument is equipped with two burner differentials related to the same nominal value and differently adjustable.

The burner differential 1 controls the required boiler temperature within the specified setting value by switching-on and -off the burner step I or II required for the current heat demand.

The burner differential 2 determines how many steps are necessary to cover the current heat demand (partial load – burner step I, total load – burner step II). This differential is superposed symmetrically to the burner differential 1 and has always to be regulated at higher values.

If the boiler temperature is below the switching-on points of both differentials, both burner steps are released whereas step II may receive an additional delay according to the setting in parameter 8.

If the boiler temperature reaches the required nominal value plus half the burner differential 1, step II is switched off, resp. if the nominal value is not reached by half the burner differential 1 switched on again. The burner differential 1 takes the control of the boiler temperature within the regulated setting value. Burner step II continues to operate in order to cover the base load.

If the required boiler temperature should be produced **by one only step** after some time (depending on the corresponding load decrease), the boiler temperature increases after switching-off of the burner step II until the switching-off point of burner differential 2 (nominal value plus half the burner differential 2) has been reached and thus burner step I is put out of operation. From that time on the allocation of the both differentials is changed, control of the boiler temperature is achieved further on by switching-on and -off burner step I within the regulated setting value of burner-differential 1.

This type of burner control causes an adaptive switching-on and -off of the currently needed burner steps depending on the corresponding heat demand and guarantees a quick regulation to the required boiler temperature.

Next parameter: yellow key

Start deceleration

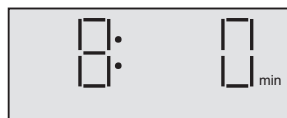

Parameter 8:
All types of instrument

Factory preset: 0 (10 sec.)
Setting range: 0 (10 sec.)...60 min.

Modification: blue key

Release of burner step II (full load step) is determined by the burner differentials and additionally by a time delay. This measure causes a blocking of the second burner step within the preset time and thus a longer runtime of burner step I. This function is effective only at the start phase (i.e. with simultaneous inquiry of both burner steps). If burner step I is at base load mode and burner step II at modulation phase (residual heat covering), the latter is connected without deceleration at any inquiry.

Next parameter: yellow key

Excessive boiler temperature



22B: **not available**
223B: **Parameter 9**
2233B: **Parameter 9**

Factory preset: 8 K
Setting range: 0...20 K

Modification: blue key

If the inquiry value of the boiler heating circuit is below that of the mixer heating circuits, the latter determine the height of the boiler temperature corresponding to their inquiry.

In order to guarantee a correct control of the mixer heating circuits with a sufficient control reserve, the highest inquiry value is admitted with a temperature increase.

Next parameter: yellow key

Minimum burner runtime

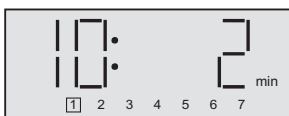

22B: **Parameter 9**
223B: **Parameter 10**
2233B: **Parameter 10**

Factory preset: 2 min.
Setting range: 0 (10 sec.)...10 min.

Modification: blue key

To increase the burner runtimes and reduce standstill times, a minimum burner runtime can be set which serves to run the burner after each switching-on at least for the time preset.

Note: The minimum burner runtime has priority against the burner differential (switch-off temperature).

If the boiler temperature should exceed the preset **maximum boiler temperature delimitation**, the burner runtime is switched off before expiry of the entered time.

Next parameter: yellow key

Minimum temperature delimitation

Mixer heating circuit 1

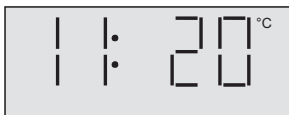

22B: **not available**
223B: **Parameter 11**
2233B: **Parameter 11**

Factory preset: 20 °C
Setting range: 10...95 °C

Modification: blue key

This function limits the flow-pipe temperature of mixer heating circuit 1 in decreasing direction according to the preset delimitation value. Below this value the outside temperature is no longer taken into consideration, the controller works in a constant operation according to the regulation.

During heating mode the temperature will not drop below the preset delimitation value.

Exceptions: Switching-off of the standby mode above the preset frost-protection limit
Switching-off at reduced automatic mode with activated ECO function
Switching-off at permanent reduced mode with activated ECO function
Automatic summer switching-off

Application: Minimum underfloor delimitation
Ventilation piloting
Convactor heating systems

Next parameter: yellow key

Maximum temperature delimitation

Mixer heating circuit 1

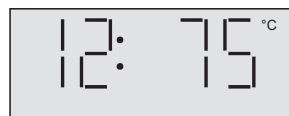

22B: **not available**
223B: **Parameter 12**
2233B: **Parameter 12**

Factory preset: 75 °C
Setting range: 10...95 °C

Modification: blue key

This function limits the flow-pipe temperature of mixer heating circuit 1 in increasing direction according to the preset delimitation value.

Above this value the outside temperature is no longer taken into consideration, the controller works in a constant operation according to the regulation.

During heating mode the preset delimitation value will not be exceeded.

Application: Maximum underfloor delimitation

Attention: In order to protect underfloor heating plants against inadmissible overheating (disturbance – manual mode), a maximum temperature delimitation should in any case be installed independently from the controller. For this purpose, we recommend a thermostat to be put on over the switch contact of which the pilot phase of the pump control circuit is looped. The thermostat is to be regulated at maximum admissible plant temperature.

Next parameter: yellow key

Minimum temperature delimitation

Mixer heating circuit 2

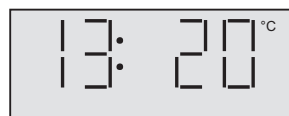

22B: **not available**
223B: **not available**
2233B: **Parameter 13**

Factory preset: 20 °C
Setting range: 10...95 °C

Modification: blue key

Function: see parameter 11 with regard to mixer heating circuit 2.

Next parameter: yellow key

Maximum temperature delimitation

Mixer heating circuit 2

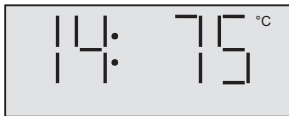

22B: **not available**
223B: **not available**
2233B: **Parameter 14**

Factory preset: 75 °C
Setting range: 10...95 °C

Modification: blue key

Function: see parameter 12 with regard to mixer heating circuit 2.

Next parameter: yellow key

Hot-water priority mode / parallel mode

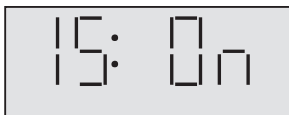

22B: **Parameter 10**
223B: **Parameter 13**
2233B: **Parameter 15**

Factory preset: ON (hot-water priority)
Setting range: OFF (priority)
OFF (parallel mode)

Modification: blue key

At priority mode, during one tank load the heating circuit pumps are switched off and mixers (if available) closed. The energy of the heating boiler is used exclusively to load the hot-water tank.

At parallel mode, the heating circuits remain in function during tank loading. Excess temperatures occurring during loading of the hot-water tank are regulated by the mixers.

Attention: At parallel mode, a directly controlled heating circuit is supplied with the tank loading temperature in case of hot-water request and does no longer work depending on atmospheric influences. This can lead to an overheating inside of rooms if the radiators are not equipped with thermostats.

Next parameter: yellow key

Tank discharge protection

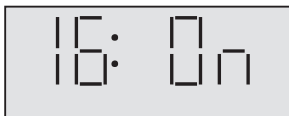

22B: **Parameter 11**
223B: **Parameter 14**
2233B: **Parameter 16**

Factory preset: ON
Setting range: ON (with discharge protection)
OFF (without discharge protection)

Modification: blue key

At activated parameter (ON), in case of a hot-water inquiry, the tank loading pump is released only if the boiler temperature exceeds the preset nominal hot-water value. With this a tank discharge is almost completely avoided and a complete boiler protection is guaranteed.

At two-step tank loading (full load), the following step is released immediately for tank loading in spite of activated outside-temperature block and switching-on deceleration.

Attention: This function should not be activated in case of hot-water regulations exceeding 60 °C in order to avoid a safety switching-off!

Next parameter: yellow key

Pump lag

Hot water loading pump - boiler heating pump

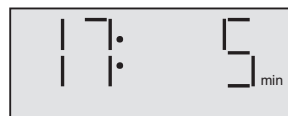

22B: **Parameter 12**
223B: **Parameter 15**
2233B: **Parameter 17**

Factory preset: 5 min.
Setting range: 0...60 min.

Modification: blue key

After switching off the burner, depending on the request, the hot water loading pump resp. the boiler heating pump is deactivated decelerated in order to avoid a safety switching-off of the boiler in case of high temperatures. The setting value is valid for both pumps.

Note: In connection with room station(s) the lag times for both pumps can be regulated individually.

Next parameter: yellow key

Bus address

Number of participant in case of heating circuit extension with additional instruments

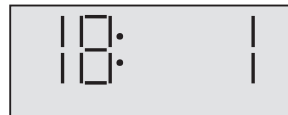

22B: **Parameter 13**
223B: **Parameter 16**
2233B: **Parameter 18**

Factory preset: 1
Setting range: 1...5

Modification: blue key

This control system allows an extension of the heating circuit with maximum five control units at the data bus interconnection each with one boiler heating circuit, hot-water circuit as well as two mixer-controlled heating circuits.

These are to be programmed with the corresponding participant number (bus address) in order to allow a selective communication between the standard unit and the interactive sub-units via the bi-directional data bus. Each sub-unit is able to transfer the data of maximum three room stations via the same data bus.

Principally, it has to be paid attention to the fact that the **standard unit** which controls the burner has always to be assigned with the **participant number 1**.

For more information, please read the operation manual for room stations RS 10.

Note: Individual setting values should be noted on the parameters' summary **Service level** (see page 28).

Exit from the Service level

Exit from the service level is achieved by a further actuation of the yellow key or automatically, **without** any actuation of the key, after approx. 60 seconds and the standard display shows.

Next parameter: yellow key

Summer-/winter time automatic

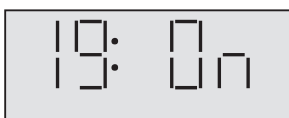

22B: **Parameter 14**
 223B: **Parameter 17**
 2233B: **Parameter 19**

Factory preset: ON

Setting range: ON = with automatic reset
 OFF = no reset (CET)

Modification: blue key

In some rare cases for which the yearly-repeating reset dates from winter to summer and vice versa do not exist, the automatic reset can be switched off.

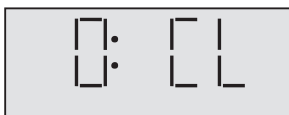

Next parameter: yellow key

Reset



All types of instrument

Attention:  Reset may only be executed if all individually entered values shall be replaced by the factory preset values!

Push blue key  **for approx. 5 sec.** 

With reset, the parameters of all levels including the individual operating times are reset to the factory preset.

In case of a reset, on the display appears the following confirmation







Reset executed

5.4 Parameter summary

On the following pages, the parameters of the individual programming levels are shown, in the order of the parameter numbers, parameter function, type of instruments and setting range. With regard to later corrections, individual regulations should be noted **in any case** in the column **setting value**.

5.4.1 Parameter summary – user level

Parameter No.			Parameter function	Setting range Indication range	Factory preset	Setting value	
22B	223B	2233B					
1	1	1	Slope of heating characteristics Boiler heating circuit	0.20...3.50	1.5		
-	2	2	Slope of heating characteristics Mixer heating circuit 1	0.20...3.50	1.5		
-	-	3	Slope of heating characteristics Mixer heating circuit 2	0.20...3.50	1.5		
2	3	4	Reduced mode	ECO – AbS	ECO		
3	4	5	Nominal hot-water value	20...80 °C	50 °C		
4	5	6	Legionella protection (day)	OFF, 1...7	OFF		
0	0	0	Parameter reset	0: CL Cancel: SEt	—		—
			Burner running time Burner step I	0000...19999 h	0000 h	Date	Count of counter
			Burner starts Burner step I	0000...19999	0000	Date	Count of counter
			Burner running time Burner step II	0000...19999 h	0000 h	Date	Count of counter
			Burner starts Burner step II	0000...19999	0000	Date	Count of counter

5.4.2 Parameter summary – service level

Parameter No.			Parameter function	Setting range Indication range	Factory preset	Setting value
22B	223B	2233B				
1	1	1	Frost protection limit	-10...+10 °C	3 °C	
2	2	2	Summer switching-off	10...30 °C	20 °C	
3	3	3	Boiler-start protection	0, 1, 2	1	
4	4	4	Minimum boiler temperature delimitation	10...95 °C	38 °C	
5	5	5	Maximum boiler temperature delimitation	10...95 °C	80 °C	
6	6	6	Burner differential 1	2...30 K	4 K	
7	7	7	Burner differential 2	2...30 K	8 K	
8	8	8	Switching-on delay burner step II	0 (10 sec.)...60 min.	0 (10 sec.)	
-	9	9	Excessive boiler temperature	0...20 K	8 K	
9	10	10	Minimum burner running time	0 (10 sec.)...60 min.	2 min.	
-	11	11	Minimum temperature delimitation Mixer heating circuit 1	10...95 °C	20 °C	
-	12	12	Maximum temperature delimitation Mixer heating circuit 1	10...95 °C	75 °C	
-	-	13	Minimum temperature delimitation Mixer heating circuit 2	10...95 °C	20 °C	
-	-	14	Maximum temperature delimitation Mixer heating circuit 2	10...95 °C	75 °C	
10	13	15	Hot-water priority Hot-water parallel mode	ON, OFF	ON	
11	14	16	Tank discharge protection	OFF, ON	ON	
12	15	17	Pump lag Boiler circuit pump Tank discharge pump	0...60 min.	5 min.	

Note: The following parameters on grey background can only be called if previously parameter 20

Parameter No.			Parameter function	Setting range Indication range	Factory preset	Setting value
22B	223B	2233B				
13	16	18	Bus address Participant number	10...5	1	
14	17	19	Summer-/winter time automatic	ON, OFF	ON	
0	0	0	Parameter reset Heating plant specialist	0: CL Cancel: SEt	-	-

5.5 External programming via service socket

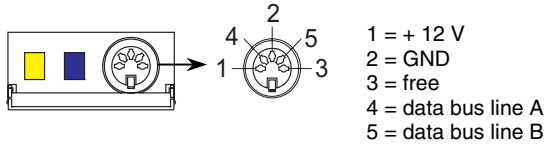

Note: The connections of the service socket are identical with the data bus connections 23 – 26 on the rear patch plugs ledge X1.

The 5-pole socket serves for programming purposes via room station RS-10.

6. Special functions

1 – Set function

(Adjustment of the controller to the system hydraulic)

All controllers of the series **Gamma** are equipped with a function which allows to deactivate control circuits which are not needed or needed only at a later time.

Log-out of control circuits

To activate this function, the corresponding sensors of the not needed control circuits have to be disconnected at switched-off control unit (mains switch on the boiler patch panel in position **OFF**). At the following switching-on of the instrument, just **during the segment test**, the blue key has to be pushed until the current sensor configuration has been confirmed by the acknowledgement **SEt** and taken over by the controller. Simultaneously, the disconnected sensors are no longer registered as sensor interruption and the appertaining heating circuit symbols are faded out on the display.

Log-in of control circuits

In case logged-out control circuits shall be logged-in again, the corresponding sensors have to be connected again and to be logged-in with the same procedure (see Log-out of control circuits).

After log-in, the corresponding heating circuit symbols appear automatically on the display.

The following sensors are detected by the set function:

- boiler sensor 1
- boiler sensor 2, resp. total flow-pipe sensor ¹⁾
- outside sensor 1
- outside sensor 2
- flow-pipe sensor 1 (mixer heating circuit 1)
- flow-pipe sensor 2 (mixer heating circuit 2),
- domestic hot-water sensor

At commissioning and activated set function, the following display character appears:

Connect control instrument

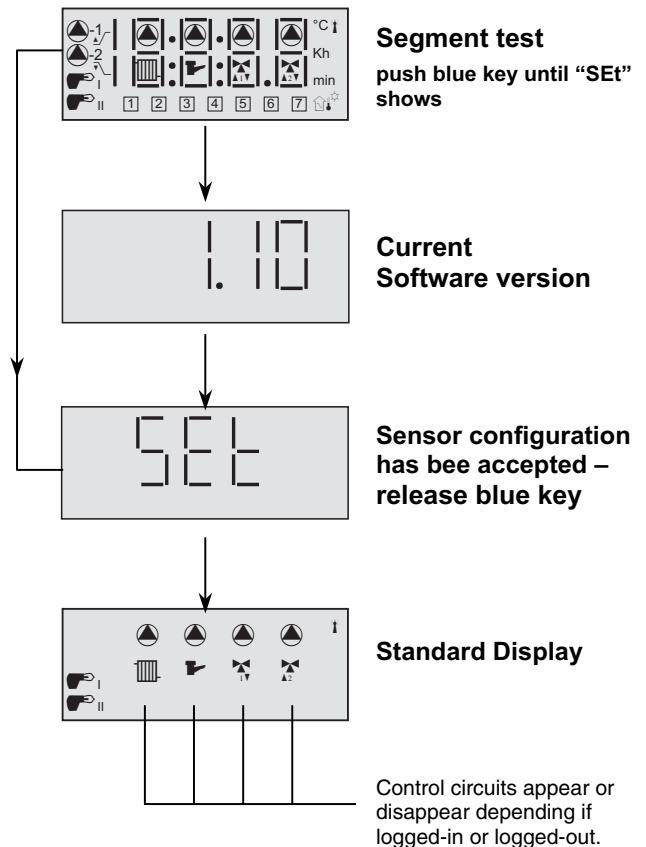

2 – Extended outside temperature control

A – Mean value method

If a second outside sensor is connected, the controller works according to the mean value of the sensors which should be installed in different directions.

Application: Single-circuit systems with seizing character varying in space.

B – Outside temperature control related to heating circuits

In case of heating circuits positioned at different directions which are exposed to different outside temperatures (e.g. north – south seizure, the outside sensors can be assigned freely.

Assignment can be made only via a room station RS 10 or by external programming. This function **cannot** be activated by the central unit.

Application: **Boiler heating circuit** (center of the building) on outside sensor 1 and 2 (mean value method)

Mixer heating circuit 1 (north) only on outside sensor 2 (installation at the north side)

Mixer heating circuit 2 (south) only on outside sensor 1 (installation at the south side)

Attention: To activate this function, the second outside sensor (AF 2) must be logged-in by means of the set function.

3 – Extended boiler temperature control

In case of heating boilers with great volumes there are normally temperature differences which can be used to increase the lifetime of the burners and to reduce standstill times.

For this purpose, a second boiler temperature sensor can be installed in the lower area of the boiler if this option has been provided by the manufacturer. The boiler temperature is controlled by an automatic commutation of the measuring point according to the request of the burner. The sensor installed at the upper area of the boiler is responsible for switching-on the burner according to the preset required value and boiler differential, the lower sensor serves for switching-off.

Example: Nominal boiler temperature = 60 °C
Differential = 6 K (± 3 K)

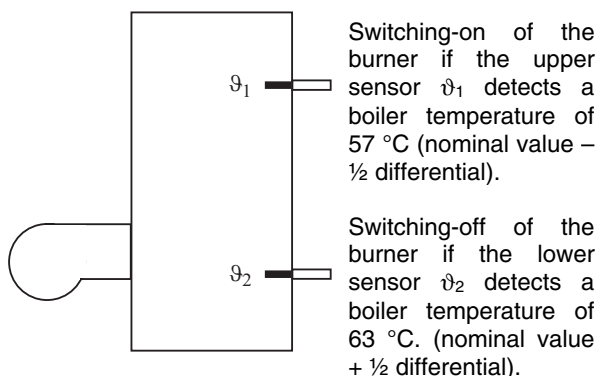

Attention: To activate this function, the second boiler sensor (KF 2) must be logged-in by means of the set function.

4 – Automatic boiler error message

If in case of a burner inquiry the boiler temperature does not increase within the regulated time, a corresponding error message occurs. The error message is indicated by a flashing burner symbol on the display.

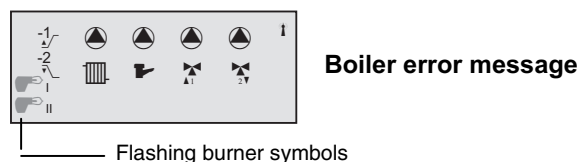

A feedback by the burner is not necessary since the error messages may have different causes (faulty boiler temperature sensor, faulty pump, etc.).

The error message is transferred additionally via data bus to all connected room stations RS 10 and avoids cooling-out losses thanks to early recognition of the error.

5 – Pump anti-blocking protection

During longer switching-off periods (standby mode, automatic and manual summer switching-off), the heating circuit pumps are switched on every day at 12.00 h for approx. 10 seconds and possibly existing mixers are opened for a short time in order to protect the pumps against blocking due to corrosion.

6 – Heating circuit extension

(Coupling of several central units to a compound system)

Heating plants with several heating- and hot-water circuits which cannot be controlled by only one instrument can be extended by coupling of further central units and corresponding control equipment. Extension is limited to five instrument types of the series Gamma. For additional mixer heating circuits as well as hot-water circuits, instruments of the series Gamma for 1-step boilers (2B, 23B, 233B) can be used.

Data exchange (outside temperature, inquiry values, hot-water temperatures, etc.) is done via a three-lead data bus line with parallel connection to the equally named terminals A, B and GND (operating ground).

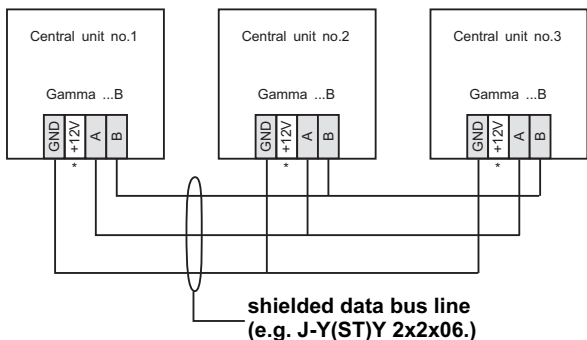

Attention: *) **Connection terminals +12V may not be bypassed!**



- GND - Connection terminal 23
- A - Connection terminal 26
- B - Connection terminal 25

7. Installation

The control instruments of the series **Gamma** are designed as units for incorporation and are installed into the corresponding patch panel from the front side after completion of the electrical installation .

The instruments are fastened by a quarter clockwise turn under slight pressure of the two laterally arranged quick-clamping devices (1).

Removal is done in opposite direction.

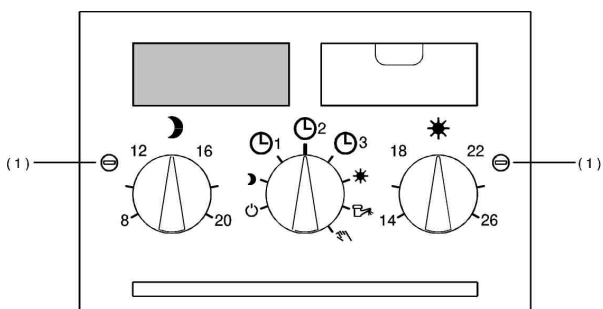

7.1 Electrical installation

Electrical installation and cabling to the control equipment is done at the back side of the instrument corresponding to the identification on the colored-marked connection panels, by means of the four terminal strips X1, X2, X3 and X4 arranged on the patch panel.

Attention: **All connecting terminals inside the blue marking work with low safety voltage and must in no case get into contact with the mains voltage! Non observance inevitably leads to the destruction of the instrument and to the loss of any warranty claims!**

Connecting terminals on the red-marked panels principally work with mains voltage according to the type of instrument and operating condition.

Seizure of the connections is shown on the next page.

Note: When wiring the instrument, attention has to be paid to a **separate** installation of sensor-resp. data bus lines and mains-alive cables. The common arrangement of wiring **within one cable** is not allowed. Sensor- and data bus lines **must not** be wired **together** with supply mains for electrical appliances which are **not** shielded according to EN 60555-2.

7.1.1 Electrical connection Gamma 22 B

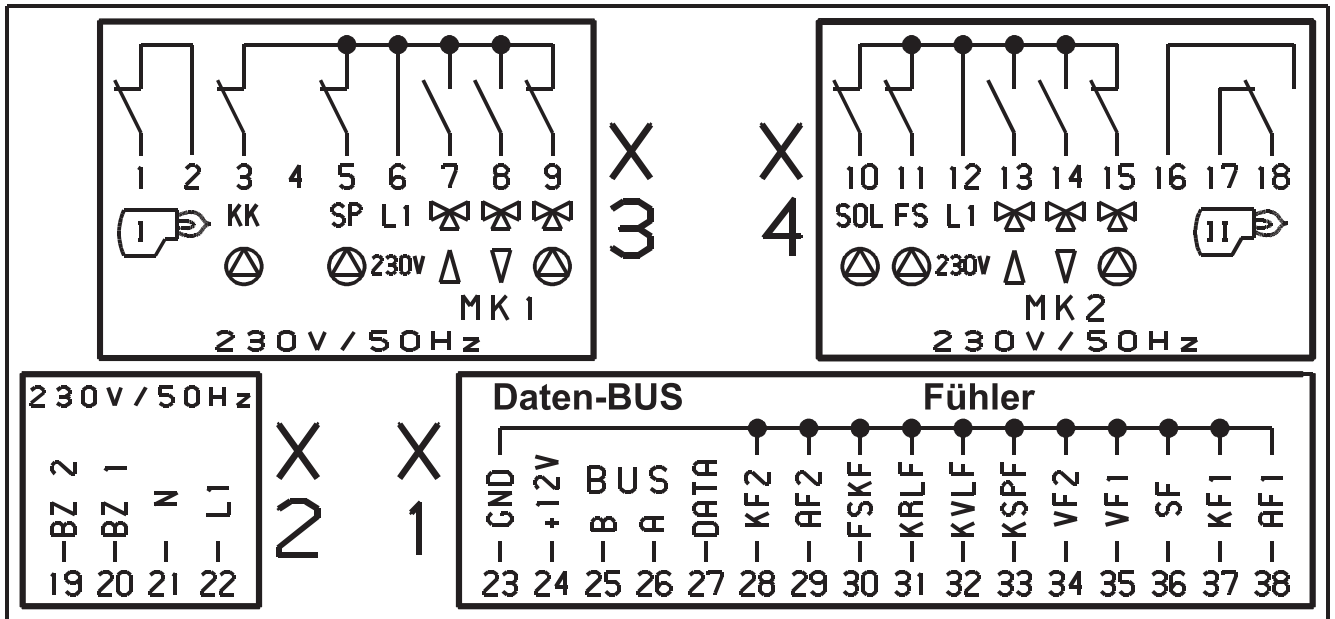

Main circuit connection

- 1 – Output burner relay – guide step
 - 2 – Input burner relay – guide step
 - 3 – Boiler (heating) circuit pump (feeding pump)
 - 4 – n.c.
 - 5 – Tank loading pump
 - 6 – L 1 / 230 V
 - 7 – n.c.
 - 8 – n.c.
 - 9 – n.c.
 - 10 – n.c.
 - 11 – n.c.
 - 12 – n.c.
 - 13 – n.c.
 - 14 – n.c.
 - 15 – n.c.
 - 16 – n.c.
 - 17 – Output burner relay – step 2
 - 18 – Input burner relay – step 2
 - 19 – Counter for operating hours– following step
 - 20 – Counter for operating hours – guide step
 - 21 – N / 230 V
 - 22 – L 1 / 230 V
- } Mains connection

Sensor-/data-bus connection

- 23 – GND for bus and sensors
- 24 – +12 V supply voltage
- 25 – Bus RS 485 signal B
- 26 – Bus RS 485 signal A
- 27 – Input radio clock receiver (optional)
- 28 – Boiler sensor 2
- 29 – Outdoor sensor 2
- 30 – n.c.
- 31 – n.c.
- 32 – n.c.
- 33 – n.c.
- 35 – n.c.
- 36 – Tank sensor (DHW)
- 37 – Boiler sensor 1
- 38 – Outdoor sensor 1

n.c.: not connected

7.1.2 Electrical connection Gamma 223 B

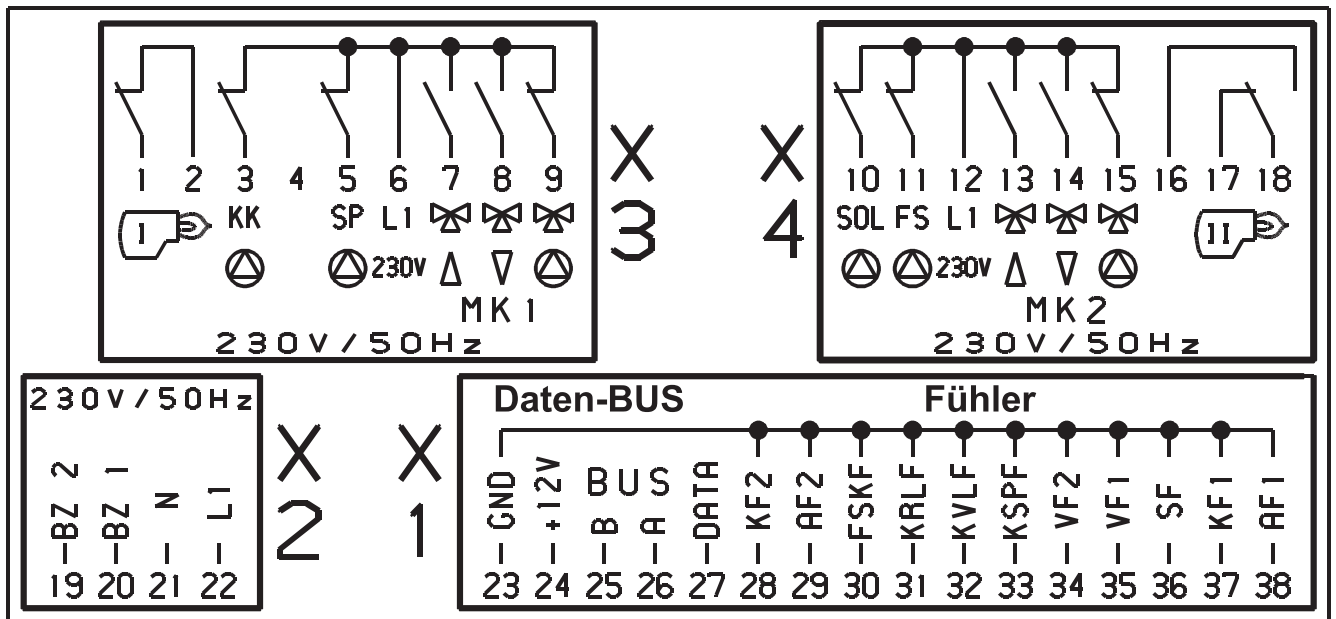

Main circuit connection

- 1 – Output burner relay – guide step
 - 2 – Input burner relay – guide step
 - 3 – Boiler (heating) circuit pump (feeding pump)
 - 4 – n.c.
 - 5 – Tank loading pump
 - 6 – L 1 / 230 V
 - 7 – Mixer valve 1 **OPEN**
 - 8 – Mixer valve 1 **CLOSED**
 - 9 – Mixer heating circuit pump 1
 - 10 – n.c.
 - 11 – n.c.
 - 12 – n.c.
 - 13 – n.c.
 - 14 – n.c.
 - 15 – n.c.
 - 16 – n.c.)
 - 17 – Output burner relay – step 2
 - 18 – Input burner relay – step 2
 - 19 – Counter for operating hours– following step
 - 20 – Counter for operating hours – guide step
 - 21 – N / 230 V
 - 22 – L 1 /230 V
- } Mains connection

Sensor-/data-bus connection

- 23 – GND for bus and sensors
- 24 – +12 V supply voltage
- 25 – Bus RS 485 signal B
- 26 – Bus RS 485 signal A
- 27 – Input radio clock receiver (optional)
- 28 – Boiler sensor 2
- 29 – Outdoor sensor 2
- 30 – n.c.
- 31 – n.c.
- 32 – n.c.
- 33 – n.c.
- 35 – Flow-pipe sensor mixer heating circuit 1
- 36 – Tank sensor (DHW)
- 37 – Boiler sensor 1
- 38 – Outdoor sensor 1

n.c.: not connected

7.1.3 Electrical connection Gamma 2233 B

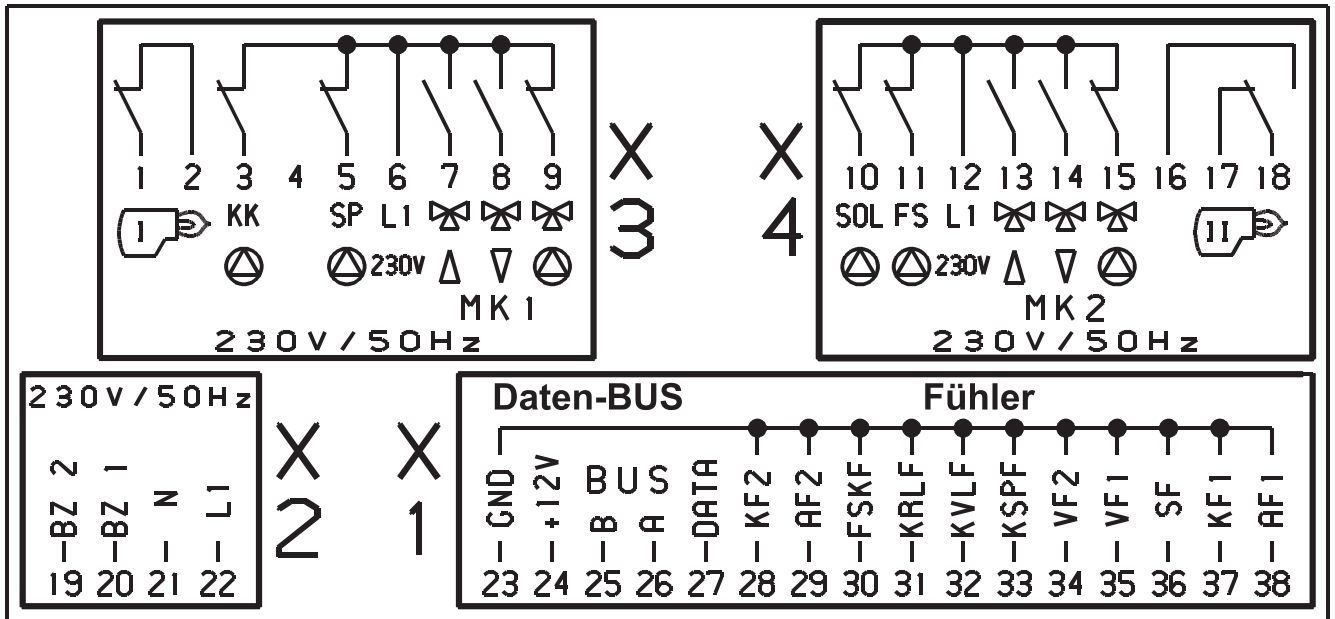

Main circuit connection

- 1 – Output burner relay – guide step
 - 2 – Input burner relay – guide step
 - 3 – Boiler (heating) circuit pump (feeding pump)
 - 4 – n.c.
 - 5 – Tank loading pump
 - 6 – L 1 / 230 V
 - 7 – Mixer valve 1 **OPEN**
 - 8 – Mixer valve 1 **CLOSED**
 - 9 – Mixer heating circuit pump 1
 - 10 – n.c.
 - 11 – n.c.
 - 12 – L 1 / 230 V
 - 13 – Mixer valve 2 **OPEN**
 - 14 – Mixer valve 2 **CLOSED**
 - 15 – Mixer heating circuit pump 2
 - 16 – n.c.)
 - 17 – Output burner relay – step 2
 - 18 – Input burner relay – step 2
 - 19 – Counter for operating hours– following step
 - 20 – Counter for operating hours – guide step
 - 21 – N / 230 V
 - 22 – L 1 /230 V
- } Mains connection

Sensor-/data-bus connection

- 23 – GND for bus and sensors
- 24 – +12 V supply voltage
- 25 – Bus RS 485 signal B
- 26 – Bus RS 485 signal A
- 27 – Input radio clock receiver (optional)
- 28 – Boiler sensor 2
- 29 – Outdoor sensor 2
- 30 – n.c.
- 31 – n.c.
- 32 – n.c.
- 33 – n.c.
- 34 – Flow-pipe sensor mixer heating circuit 2
- 35 – Flow-pipe sensor mixer heating circuit 1
- 36 – Tank sensor (DHW)
- 37 – Boiler sensor 1
- 38 – Outdoor sensor 1

n.c.: not connected

8. Accessories

Outdoor sensor AF 200

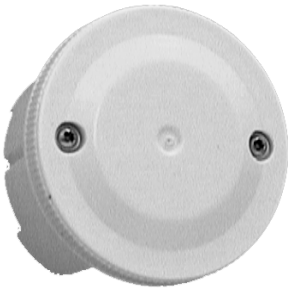

In case of atmospheric-influenced heating mode, the controller is operated with one resp. two outdoor sensors AF 200.

Installation

The outdoor sensor should be installed at approx. one third of the building height (minimum distance to floor ground 2 m) at the coldest side of the building (north resp. north-east). In case of another preferred seizure direction the corresponding side of the building has to be chosen.

For the installation of the sensor other heat sources (chimneys, hot air from air shafts, sunlight, etc.) which could falsify the measured value have to be considered. Cable exit has to be directed always to the bottom in order to avoid penetration of humidity.

For the electrical installation a 2-core cable with a minimum cross section of 1 mm² is prescribed.

Attention: Principally, the sensor line has to be laid separately. The parallel laying of sensor- and mains lines inside one only cable duct is not allowed and can lead to considerable disturbances of the control operation!

Cable sensor KVT 20



Boiler sensor
Hot-water sensor

The temperature sensor KVT 20 is designed as immersion sensor and serves to detect boiler- and domestic hot water temperatures.

The immersion case is entered into the boiler together with the sensor elements of the safety temperature delimiter (STB), the boiler temperature controller (KTR) and the boiler temperature indication (KTA). The tensioning spring integrated in the sensor provides the necessary contact pressure and has to be bent in direction of the sensor point prior to entering into the immersion case.

Attention has to be paid to that the sensor cable is not bent or damaged. If necessary, the sensor cable can be extended. The boiler sensor is identical with regard to the electrical values and distinguishes against the other sensors only by the length of the connection cable (boiler sensor = 2 m, all other cable sensors = 5 m).

The diameter of all sensor elements is 6 mm.

Flow-pipe sensor VF 202



The flow-pipe sensor VF 202 (alternatively to be used as return-flow sensor) serves to measure the flow-pipe temperature of mixer controlled heating circuits.

Installation

The sensor should be installed in a distance of at least 50 cm to the circulation pump on a metallic bright point of the flow pipe.

The sensor is attached to the pipe with the supplied tightening strap even with the pipe surface. The enclosed heat-conduction paste serves for a better heat transfer and has to be applied at the contact point **prior to the installation**.

The flow-pipe sensor VF 202 is supplied with integrally cast cable (cable length 2 m) which can be extended if necessary.

9. Resistance values of the sensor elements depending on the temperature

for outside sensor AF 200
 boiler sensor KVT 20
 flow-pipe sensor VF 202
 hot-water sensor KVT 20

Temperature (°C)	Resistance (KΩ)	Temperature (°C)	Resistance (KΩ)	Temperature (°C)	Resistance (KΩ)
- 20	1.383	6	1.727	50	2.395
- 18	1.408	8	1.755	55	2.478
- 16	1.434	10	1.783	60	2.563
- 14	1.459	12	1.812	65	2.648
- 12	1.485	14	1.840	70	2.735
- 10	1.511	16	1.869	75	2.824
- 8	1.537	18	1.898	80	2.914
- 6	1.563	20	1.928	85	3.005
- 4	1.590	25	2.002	90	3.098
- 2	1.617	30	2.078	95	3.192
0	1.644	35	2.155	100	3.287
2	1.671	40	2.234	105	3.382
4	1.699	45	2.314	110	3.478

10. Accessories on demand

Optional accessories for heating circuit extension only



Room station RS-10

The room station RS 10 increases the operational comfort considerably due to local control and handling possibilities since each heating circuit can be assigned with its own room station.

Furthermore, the central unit contains different functions which can be activated only in the room station.

These include amongst others:

- optimization functions
- user-definable room-temperature cycles
- automatic adaptation of heating characteristics
- regulation of climatic zones

By means of five control keys, plant-specific temperatures and operating times can be inquired and modified, and individual plant programs can be entered.

Furthermore, functions such as party switch, program selection, coded accessible plant parameters, etc. are available.

Besides the current data, such as time, date, outside- and room temperature, a clear display indicates also all plant data (nominal and real temperatures, parameter values, program indications, etc.) and informs about irregular operational conditions (fault messages).

Room sensor with remote control RFF 60 S



RFF 60S

These accessories detect the current room temperature and allow to correct the desired room temperature by ± 6 K.

The integrated selector switch allows the continuous heating resp. temperature reduction or automatic mode according to the automatic program preset at the central unit.

Electrical connection

The electrical coupling of one resp. several accessories with the central unit is done via a four-core **shielded** data-bus line (preferably unit-stranded cable J – Y [St] Y 2 x 2 x 0.6).

Connection is done at the equally named connecting terminals.

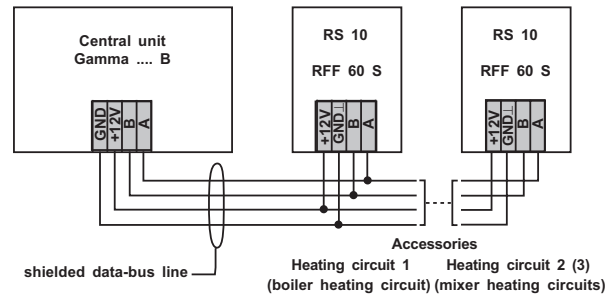

Radio-clock module FU 77

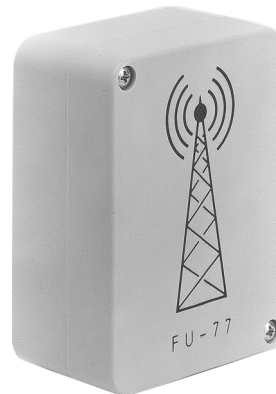

On demand, the central unit can be equipped with a radio-clock module receiver. This module will be installed at a spot suitable for receipt **inside the building** and connected with the corresponding connections of the controller.

If a sufficient receipt is guaranteed, the time model radiated by the DCF-77 transmitter causes a synchronization precise to one second of the switch clock integrated in the instrument and corrects all time- and calendar relevant data automatically.

In case of connected room stations RS-10 the switch clocks integrated in these accessories are also synchronized.

At the combination of several central units, the radio-clock module can be connected to any one of the control units. Synchronization of the other central units is done on the common data-bus line.

Notes:

11. Technical data

General

Connecting voltage: 230 V + 6%/-10%
Nominal frequency: 50-60 Hz
Pilot fuse: max. 6.3 A / time-lag type
Relay exits:
 Contact scanning:
 Relay for burner 8 A ($\cos \Phi \geq 0.8$)
 All other relays 6 A ($\cos \Phi \geq 0.8$)
Casing dimensions: 144 x 96 mm (W x H)
Ambient temperature: 0°C...50°C
Storage temperature: -25°C...60°C
Protection type: IP 30
Protection class
according to EN 60529: III
Radio protection: EN 55014 (1993)
Resistance to disturbances: EN 55104 (1995)
EC conformity: 89/336/EC
Switch clock:
 To each heating circuit as well as to the
 hot-water circuit 2 operating cycles per
 day (14 per week) can be assigned.
 The smallest operating interval is 30 min.
Data storage: several years
Selector switch:
 8 positions (including the
 3 clock operating programs)
Bus interface:
 RS 485 for the connection of a PC
 respectively
 laptop, room station or modem

Control of the hot-water circuit

Nominal hot-water temperature: 20°C...80°C
 Factory preset: 50°C
Operating difference:
 Factory preset: 5 K

Control of the boiler circuit

Daytime ambient temperature:
 14°C...26°C
 Factory preset: 20°C
Reduction temperature:
 8°C...20°C
 Factory preset: 14°C
Minimum delimitation:
 Factory preset: 38°C
Maximum delimitation:
 10°C...95°C
 Factory preset: 80°C
Burner differential 1:
 2...30 K
 Factory preset: 6 K
Burner differential 1:
 2...30 K
 Factory preset: 8 K

Boiler parallelism
 0...20 K
 Factory preset: 8 K
Minimum running time of burner:
 0...10 min.
 Factory preset: 2 min.
Heating curve:
 0.20...3.5
 Factory preset: 1.50

Control of mixer heating circuits

Control operating:
 Three-point controller with
 PI characteristic
Daily ambient temperature:
 14°C...26°C
 Factory preset: 20°C
Decreasing temperature:
 8°C...20°C
 Factory preset: 14°C
Minimum delimitation:
 10°C...95°C
 Factory preset: 20°C
Maximum delimitation:
 10°C...95°C
 Factory preset: 75°C
Heating curve:
 0.20...3.50
 Factory preset: 1.00

Other technical data

Frost protection:
 -10°C...10°C
 Factory preset: 3°C
Outside-temperature switch off:
 10°C...30°C
 Factory preset: 20°C
Pump lag:
 0...60 min.
 Factory preset: 5 min
Legionella protection
 65°C once a week

Subject to change
Art. 0450007012 - 0446